

Description

The DC0504S2-5L are monolithic voltage suppressors designed to protect components which are connected to data and transmission lines against ESD.

These devices will also provide protection in accordance with IEC 61000-4-2 and IEC 61000-4-4 requirements. These devices are available in a SOT23-5L package configuration and is rated at 100W peak pulse power(8/20µs) per line.

Features

- ◆ 4 bidirectional ESD protection
- ◆ Low operating voltage: 5V
- ◆ 100W peak pulse power (8/20 µs)
- ◆ Complies with following standards:
 - IEC 61000-4-2 (ESD) immunity test
Air discharge: ±30kV
Contact discharge: ±30kV
 - IEC61000-4-4 (EFT) 40A (5/50ns)
 - IEC61000-4-5 (Lightning) : 8A(8/20µs)
- ◆ ROHS Compliant

Mechanical Characteristics

- ◆ Package: SOT23-5L
- ◆ UL Flammability Classification Rating 94V-0
- ◆ Case Material: “Green” Molding Compound
- ◆ Moisture Sensitivity: Level 3 per J-STD-020
- ◆ Terminal Connections: See Diagram Below
- ◆ Marking Information: See Below

Applications

- ◆ Computers
- ◆ Printers
- ◆ Communication systems
- ◆ Cellular phone handsets and accessories
- ◆ Other telephone set
- ◆ Set top boxes

Dimensions and Pin Configuration

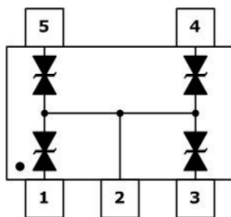

Circuit and Pin Schematic

Marking Information

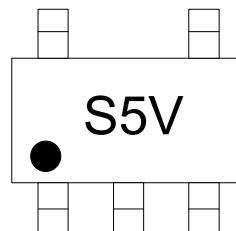

Dot denotes Pin1

Ordering Information

Part Number	Marking	Packaging	Reel Size
DC0504S2-5L		3000/Tape & Reel	7 inch

Absolute Maximum Ratings ($T_A=25^{\circ}\text{C}$ unless otherwise specified)

Parameter	Symbol	Value	Unit
Peak Pulse Power (8/20 μs)	Ppk	100	W
Peak Pulse Current (8/20 μs)	Ipp	8	A
ESD per IEC 61000-4-2 (Air)	VESD	± 30	kV
ESD per IEC 61000-4-2 (Contact)		± 30	
Operating Temperature Range	TJ	-55 to +125	$^{\circ}\text{C}$
Storage Temperature Range	Tstg	-55 to +150	$^{\circ}\text{C}$

Electrical Characteristics ($T_A=25^{\circ}\text{C}$ unless otherwise specified)

Parameter	Symbol	Min	Typ	Max	Unit	Test Condition
Reverse Working Voltage	VRWM			5	V	
Breakdown Voltage	VBR	6		8	V	IT = 1mA
Reverse Leakage Current	IR			0.2	μA	VRWM = 5V
Clamping Voltage	VC			8	V	I _{PP} = 1A (8 x 20 μs pulse)
Clamping Voltage	VC			13	V	I _{PP} = 8A (8 x 20 μs pulse)
Junction Capacitance	CJ		18		pF	VR = 0V, f = 1MHz

Typical Performance Characteristics (TA=25°C unless otherwise Specified)

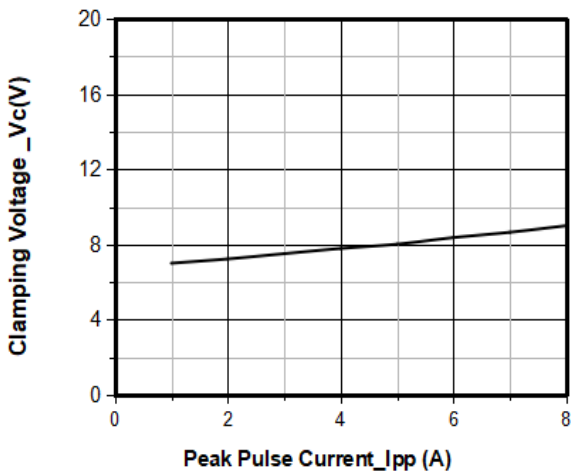

Junction Capacitance vs. Reverse Voltage

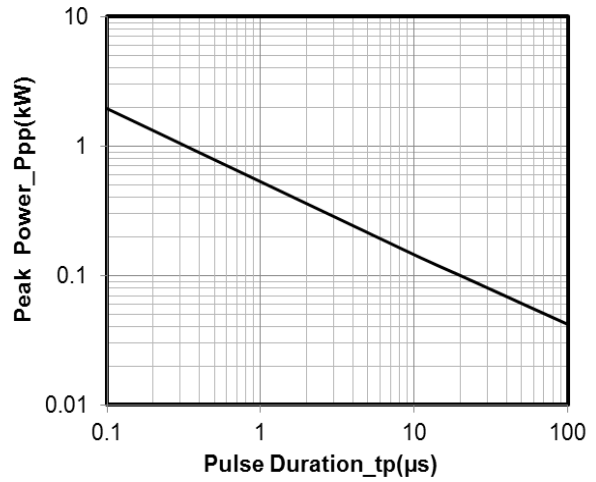
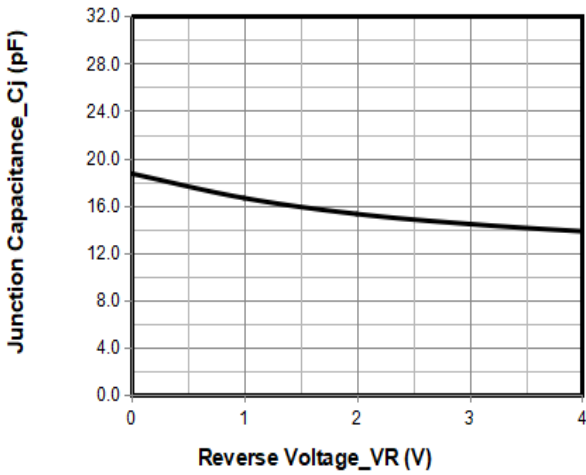

Peak Pulse Power vs. Pulse Time

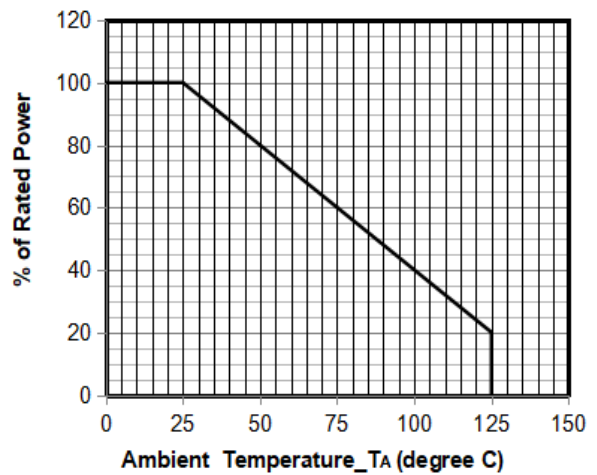

Clamping Voltage vs. Peak Pulse Current (tp = 8/20us)

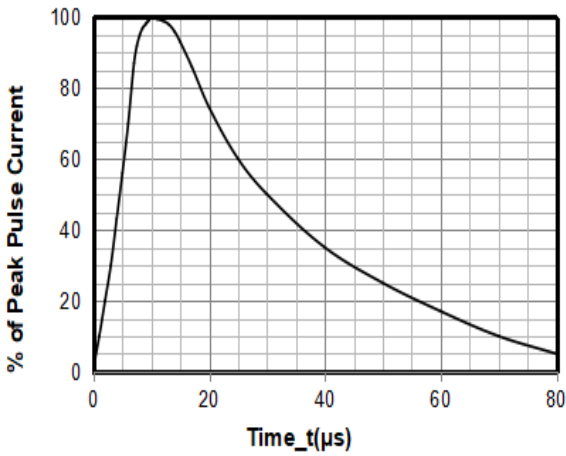

Power Derating Curve

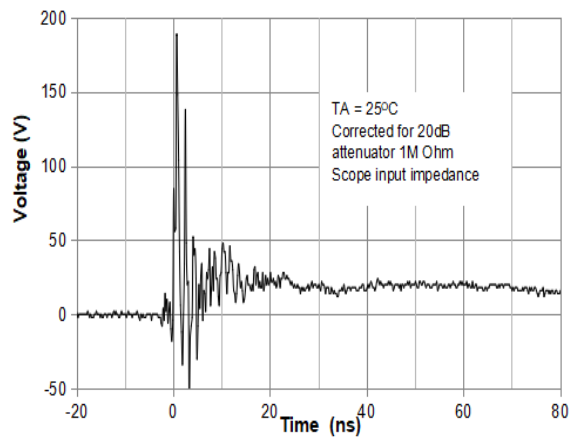

ESD Clamping Voltage

8 kV Contact per IEC61000-4-2

SOT23-5L Package Outline Drawing

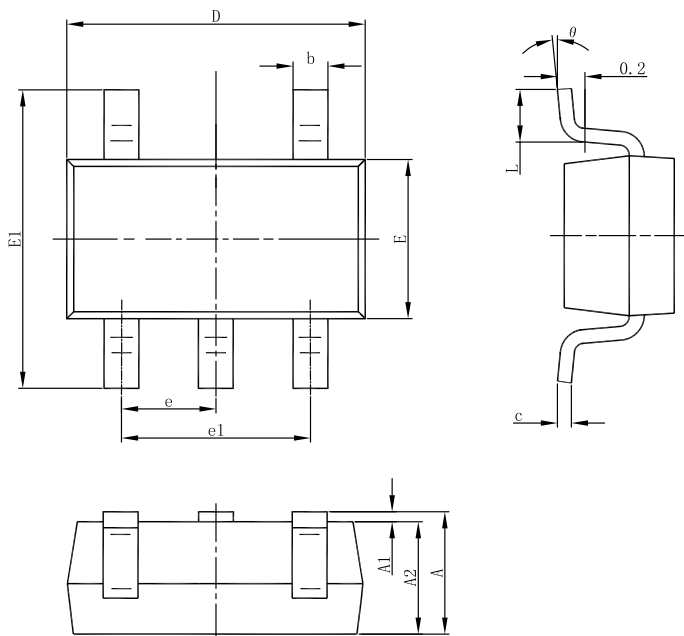

Symbol	Dimensions			
	Millimeters		Inches	
	Min	Max	Min	Max
A	1.050	1.250	0.041	0.049
A1	0.000	0.100	0.000	0.004
A2	1.050	1.150	0.041	0.045
b	0.300	0.500	0.012	0.020
c	0.100	0.200	0.004	0.008
D	2.820	3.020	0.111	0.119
E	1.500	1.700	0.059	0.067
E1	2.650	2.950	0.104	0.116
e	0.950(BSC)		0.037(BSC)	
e1	1.800	2.000	0.071	0.079
L	0.300	0.600	0.012	0.024
θ	0°	8°	0°	8°

Suggested Land Pattern

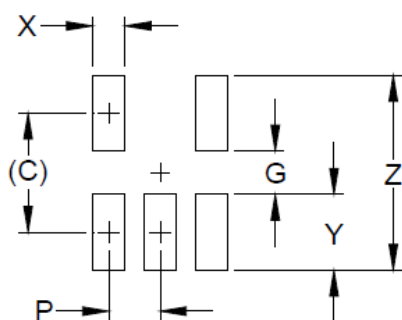

SYM	DIMENSIONS	
	MILLIMETERS	INCHES
C	2.50	0.098
G	1.40	0.055
P	0.95	0.037
X	0.60	0.024
Y	1.10	0.043
Z	3.60	0.141

Contact Information

Changzhou D-first Electronics CO.,Ltd.

www.first-electronic.com

Email: xhf@first-electronic.cn

Phone: +86 (0519) -8817 1671